



FES R2300 High Power Charger

User manual, Version 1.1



Table of Content

- 1. Important notices 3
 - 1.1 Limited Warranty 3
 - 1.2 Invalid Warranty 3
- 2. Introduction 4
 - 2.1 Technical characteristics..... 4
 - 2.1 Dimensions 5
 - 2.2 Installation and Warnings..... 5
- 3. Safety Instructions 6
- 4. Lights and push buttons 6
- 5. How to use 7
- 6. Light symbol definitions 10
 - 6.2 Indications and what they mean 10
- 7. Revision history 11

1. Important notices

This user manual contains important information about proper and safe usage of FES R2300 Battery charger. If you need more information, please contact LZ design.

Information in this document are subject to change without notice. LZ design reserves the right to change or improve this product and to make changes in the content of this material without obligation to notify any person or organization of such changes or improvements.



Caution: A Yellow triangle is shown for parts of the manual which should be read carefully and are important.



Warning: Notes with a red triangle describe procedures that are critical and may result in reduced safety or may lead to critical situation.



Note: A bulb icon is shown when a useful hint is provided to the reader.

1.1 Limited Warranty

This product is warranted to be free from defects in materials or workmanship for two years from the date of purchase. Within this period, LZ design will, at its sole option, repair or replace any components that fail in normal use. Such repair or replacement will be made at no charge to the customer for parts and labour, however the customer shall be responsible for any transportation cost.

Usage of device is at user's own risk. LZ design will not under any circumstances accept any responsibility or will be liable for possible damage on people, animals, or things, which might directly or indirectly happen from using FES R2300 High power charger.

In the case of a fault/damage or to obtain a warranty service, contact LZ design directly. Only authorized persons can repair the charger.

1.2 Invalid Warranty

The warranty does not cover failures due to abuse, misuse, accident, or unauthorised alterations or repairs.

2. Introduction

The FES R2300 High power charger is a charger, programmed especially for FES Battery packs by LZ Design. It uses modern switching technology. The intelligent microcontroller extends the life of the battery by supervising the charging process. The charger is compact, silent and meets the EU safety and EMC requirements. Protection class against water & dirt is IP54.

The charger is protected against reverse polarity and short circuit, has adjustable time limitations for every charging phase, battery temperature monitoring and compensation and current reduction at elevated ambient temperatures.

To change the charging profile for another specific battery type, parameters can only be programmed with a PC software package and a programming interface by LZ design.



Warning: *Required input voltage is 230 V~50/60 Hz. Unfortunately, the US 110V version is not available yet. If you need powerful charger compatible with 110V grid we can offer you another charger type FES KOP2300.*



Warning: *Before using the charger, check if the fuse on the grid is suitable. For 2300 W charger there should be minimum 16 A rated fuse. Such powerful charger should be always connected directly to outlet, without extension cables and splitters in between.*



Caution: *If you have another pair of Battery pack, make sure that you do not mix packs between the two sets. The same two packs of one set (first marked as A, second marked as B) must always be used in pair!*

2.1 Technical characteristics

FES R2300 High Power charger	
Max. charging voltage / current	58 V / 30 A
Input voltage	195 – 264 V, 47 – 64 Hz
Output voltage accuracy	+/- 0,5 %
Output current accuracy	+/- 2 %
Mains cable	3 x 1,5 mm ² Rubber cable
Battery cables	2 x 25 mm ²
IP class	IP54
Housing	Aluminium
Ambient temperature	-35 °C - +55 °C
Dimensions (L x W x H)	367 x 230 x 83 mm
Weight	6,1 kg
Other	Wrong polarity protection, short circuit protection

2.1 Dimensions

Dimensions of FES R2300 battery charger:

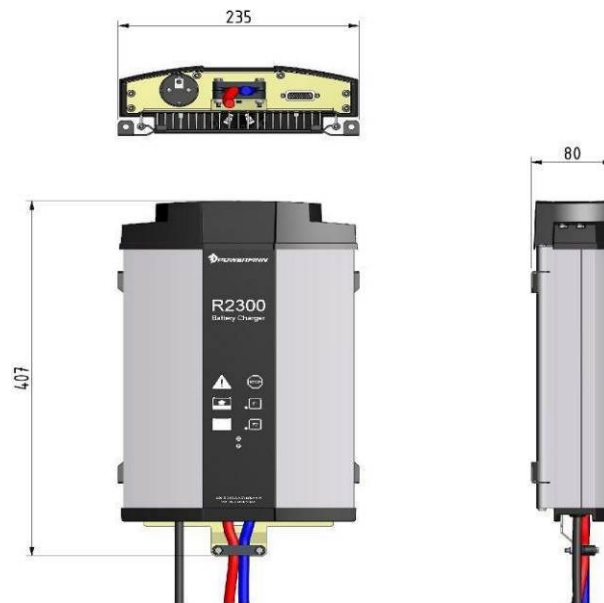

2.2 Installation and Warnings

The following points must be respected when choosing a location for the charger:

1. The charger is to be installed vertically on a concrete or other non-combustible surface only.
2. To ensure sufficient ventilation, leave a free space of at least 10 cm around all sides and 30 cm on top and bottom of the charger. Do not cover the unit.
3. Never use an open flame or equipment that produces sparks close to the charger.
4. In fixed installation the operation temperature range is $-35\text{ }^{\circ}\text{C}$ to $+55\text{ }^{\circ}\text{C}$. The temperature higher than $+40\text{ }^{\circ}\text{C}$ will limit the output power. Mains cord & battery cable "indoor use" min temperature is $+5\text{ }^{\circ}\text{C}$. Do not bend in cold environment.

Charger should be preferably permanently installed **vertically** on the wall.

FES R2300 High Power Charger is programmed and equipped for charging **FES 14S battery packs**.

3. Safety Instructions



The following personal precautions should be taken whenever charging batteries:

1. Do not bring burning or sparking matter to the vicinity of the battery when it is being charged.
2. If a short circuit occurs, the battery may explode or the item causing the short circuit may melt. Keep the charging area clear from tools and debris. Remove jewellery, watches etc. before working with battery.
3. The power cord should be unplugged, and the battery must be disconnected from the charger in case the equipment is left unused for a longer period of time.
4. The charger must be located away from heat source like radiators or similar.
5. This device is not meant to be used by children or people whose physical sensory or mental attributes or lack of experience and knowledge prevent them from using the device safely.

4. Lights and push buttons

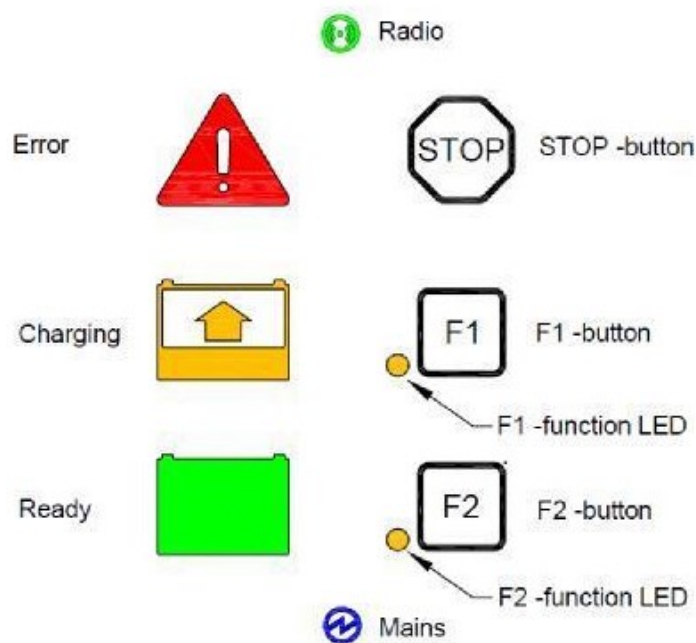
FES R2300 battery charger’s front label looks like this:



Symbol / Light	Meaning
	Main is connected (when the light is ON).
	Radio module is not in use with FES R2300 battery charger.

5. How to use

Read these operating instructions carefully before using the charger for the first time.

Charger is configured with factory default settings.



Caution: Place charger on a safe, secure position. Keep away from dust, direct sunlight, fire, smoke, children and any unattended person!



Warning: Before charging, physical condition inspection of the battery packs should be done. Any sign of mechanical damage, such as a puncture, dents or scratches, must be evaluated and reported to manufacturer before charging.

To charge a FES battery pack with FES R2300 charger, please follow these instructions:

1. Ensure that the charger is unplugged.
2. Connect the **blue negative (-)** charging cable of charger into the negative **blue (-) terminal** of FES battery pack
3. Connect the **red positive (+)** cable in three steps:

Step 1 – Put the **red positive (+)** cable only about **5 mm** into the **red positive (+)** battery pack terminal.

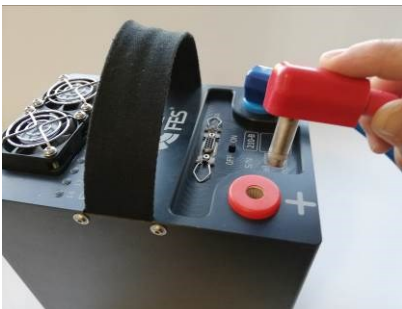

Step 2 – Wait for about **3 seconds** to avoid sparking.

Step 3 – Plug in the positive cable to its end position.



4. Connect the Charger and the Battery pack with FES R2300 BMS-Charger-PC cable.



FES R2300 Charger BMS PC Cable

5. Plug in the charger to (220V AC, 50-60 Hz only) outlet.

6. Turn on the BMS switch on top of the Battery pack cover.

Immediately after BMS is switched ON, the BMS starts a test procedure - a check of all 14 cells, one by one. Red »Error LED« turns ON during system's test procedure and turns OFF again when the test is completed without error.

After the test procedure, several LEDs turn ON for about 1 second. The number of the LEDs that light up, represent a state of charge (SOC) of the battery pack. Each LED represents around 7% SOC, for example:

- 2 LEDs are lit: SOC is approximately 14%
- 7 LEDs are lit: SOC is approximately 50%
- 14 LEDs are lit: SOC is approximately 100%

7. When the test procedure is completed the green »Power LED« starts blinking indicating that the BMS is working in the normal mode. At this time, BMS sends a signal to the charger to start charging. Orange LED on front panel of the charger lights up, which indicates charging. It is also possible to hear the contactor "click" inside of the charger. Charging current increases slowly to the maximum value of 9 A (or 18 A at 1200 W, 35 A at 2000 W) and charger cooling fans turn on after a while.

8. In normal mode, the green »BMS Power« LED is flashing. This means that the BMS is turned ON, but not necessary balancing. Balancing starts when one cell reaches a pre-set balancing voltage value, usually 4.1 (this can be changed using BMS Control Software). If any of 14 green LED cell balancing indicators is ON, this means that the corresponding cell has a slightly higher voltage compared to the cell with the lowest voltage.

- If one or more cells have higher voltage than the others, they will be discharged and the BMS temperature rise will be minimal.
- In case that one cell has lower voltage than the others, all cells with higher voltage will need to be discharged to reach a balanced stat. This leads to higher BMS temperature rise, even if the voltage difference is only 0.010 V (10 mV).

The cooling fans turn on when the BMS cooling plate reaches 50°C.



Caution: Cooling fans may not be able to cool down the BMS sufficiently in hot conditions and the temperature of the BMS cooling plate can continue rising. In this case, charging is interrupted automatically when the BMS cooling plate reaches 55°C, until it drops to 45°C and charging resumes

9. The red »Error LED« is ON only during the initial test procedure. After the test is finished it turns OFF. If a system error is detected the LED blinks a certain number of times followed by a pause. The number of blinks identifies the error as per table on page 12.
10. When the first cell reaches 4.160 V, charging current is reduced. If there is a big difference between the cells (more than 50 mV), it can take long for all of them to reach 4,16 V, as charging current is reduced to 1 A.
11. When all cells reach 4.160 V (+/- 2mV), **BMS sends a signal to the charger to stop charging.**

The **Green** "Power LED" stops flashing and starts **glowing Green**.

This indicates that the charging cycle was completed properly.

12. Switch OFF BMS on top of the Battery pack. Unplug charger from the outlet. Unplug charging cables and signal cable from the battery pack.



Warning: Both battery packs **must have** approximately the same cell voltage levels (close to 4.16 V per cell), before usage. Using two packs with too much difference in voltage levels is not allowed! Maximum 1V difference between total voltages of both packs is acceptable.

For instance, Pack 1: 58,1 V (average 4.150 per cell), Pack 2: 57,1 V (4,080 V per cell), this is just acceptable! Bigger voltage difference is not acceptable!











Note: Pressing **STOP** will PAUSE charging. Pressing STOP again will RESUME charging. No function is assigned to **F1 and F2 buttons**.









Caution: If there is a risk of a lightning strike by an approaching thunderstorm, stop charging immediately and disconnect the charger from the outlet.

6. Light symbol definitions

	Error	Charging	Ready
No light			
Continuous light			
Flashing			

6.2 Indications and what they mean

			None of indicators are lit: Charger is waiting for a battery connection. Only small blue led lights continuously.
			Green flashing: STOP pressed, charging paused.
			Yellow continuously lit: main charging phase. Defined in charging algorithm.
			Additional charging. Defined in charging algorithm.
			Equalize charging. Defined in charging algorithm.
			Charging ready, maintenance charging. Defined in charging algorithm.
			Alarm, no specific.
			Alarm, low battery voltage. Defined in charging algorithm.
			Alarm, high battery voltage. Defined in charging algorithm.
			Alarm, time limit exceeded. Defined in charging algorithm.
			Alarm, Ah limit exceeded. Defined in charging algorithm.
			Alarm, invalid charging parameters.
			Alarm, high charger temperature.
			Alarm, low charger temperature or sensor fault.
			Alarm, regulation fault.

7. Revision history

August 2019	Initial release, user manual v1.0
April 2020	Minor change, user manual v1.1